

WM20

Power analyzer for three-phase systems



Description

WM20 is a modular power analyzer for single-, two- and three-phase systems. It is made up of a maximum of three components: the main unit that displays measurements on the LCD display and manages two alarms, and two accessory modules, one with digital outputs and the other for communication. The digital output module associates alarms with static or relay outputs and/or transmits pulses proportional to energy consumption. The communication module allows you to configure the analyzer and transmit data using a different communication protocol according to the version.

Applications

WM20 can be installed in any switchboard to control energy consumption, main electrical variables and harmonic distortion.

In automation, WM20 can use the communication module with Profibus protocol to both communicate data on consumption to supervision systems and manage them independently if installed on a machine.

In building, WM20 can be installed in existent architectures using the communication module with BACnet protocol (on RS485 or Ethernet).

Main functions

- Measure main electrical variables and voltage and current harmonic distortions
- Measure active and reactive energy

Benefits

- **Clarity.** The wide backlit LCD display clearly shows the measurements and the configuration parameter values.
- **Simplicity.** The rotating pages function automatically shows all measurements in sequence without having to use the keypad. An optical port is available for quick analyzer configuration using OptoProg (CARLO GAVAZZI).
- **Specific software.** WM20 can be configured and measurements viewed from UCS configuration software (CARLO GAVAZZI). The software and subsequent updates are free.
- **Scalability.** Two accessory modules can be added to WM20 according to need. This way, the analyzer extends its control capacities and communicates data remotely.
- **Communication flexibility.** The communication module is available in Modbus RTU, Modbus TCP/IP, BACnet IP, BACnet MS/TP and Profibus DP V0 versions.
- **Fast installation.** WM20 and accessory modules are all equipped with detachable terminals. Modules can be quickly installed via the specifically designed fast coupling pins.
- **Tamper-proof.** WM20 configuration access can be locked. Terminals and accessory modules can be sealed.
- **Installation flexibility.** WM20 is suitable for singlephase, two-phase, three-phase and wild-leg systems.

- Measure load operating hours
- Manage up to two alarms
- Manage two digital outputs (via optional accessory module)
- Transmit data to other systems (via optional accessory module)

Components

Module	Description
WM20	Main unit, measures and displays main electrical variables. With LCD display and touch keypad, it lets you set measurement parameters, configure accessory modules and manage up to two alarms.
Digital outputs (optional)	Accessory module with two digital outputs. Expands main unit capacity, specifically allowing you to: Transmit pulses proportional to energy consumption Control digital outputs (static or relay according to the module)
Communication (optional)	Accessory module that lets you transmit data to other systems or configure the analyzer from remote

Compatible accessory modules

Type	Module description	Code
Digital outputs	Double static output	M O O2
	Double relay output	M O R2
Communication	Modbus RTU communication on RS485/RS232	M C 485232
	Modbus TCP/IP communication on Ethernet	M C ETH
	BACnet IP communication on Ethernet	M C BAC IP
	BACnet MS/TP communication on RS485	M C BAC MS
	Profibus DP V0 communication on RS485	M C PB

Possible configurations

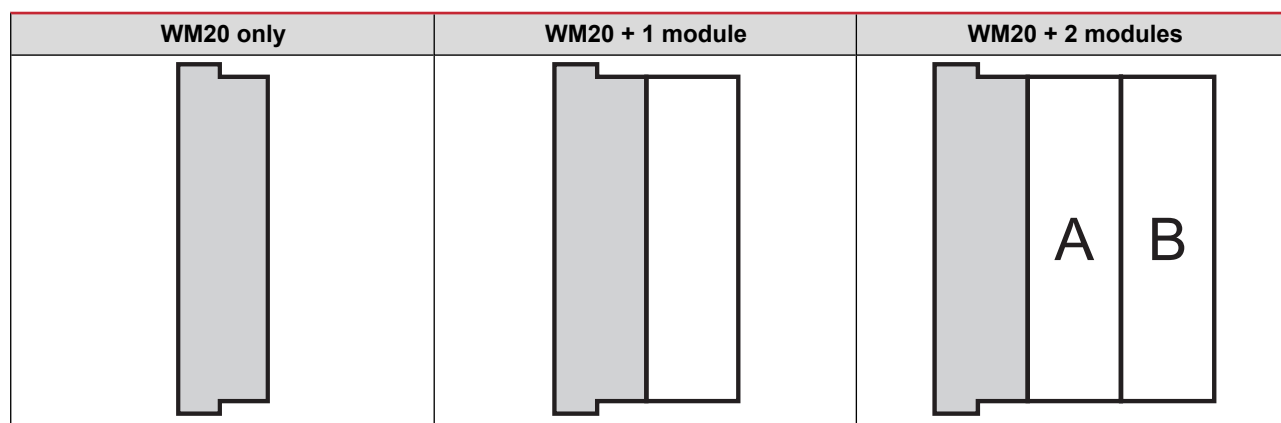

NOTICE: maximum 1 module per type. In the configuration with 2 modules, the communication module is installed last.

Features

General

Material	Front: ABS, self-extinguishing V-0 (UL 94) Back and accessory modules: PA66, self-extinguishing V-0 (UL 94)
Protection degree	Front: IP65 NEMA 4x NEMA 12 Terminals: IP20
Terminals	Type: detachable Section: 2.5 mm ² maximum Torque: 0.5 Nm
Overvoltage category	Cat. III
Pollution degree	2
Rejection (CMRR)	100 dB, from 42 to 62 Hz
Insulation	Double electrical insulation on areas accessible to the user. For insulation between inputs and outputs, see "Input and output insulation".

Input and output insulation

Note: test conditions: 4 kV rms ac for one minute.

Type	Power supply (H or L) [kV]	Measurement inputs [kV]	Digital outputs [kV]	Serial port [kV]	Ethernet port [kV]
Power supply (H or L)	-	4	4	4	4
Measurement inputs	4	-	4	4	4
Digital outputs	4	4	-	4	4
Serial port	4	4	4	-	NP
Ethernet port	4	4	4	NP	-

Key

- NP: combination not possible
- 4: 4 kV rms insulation (EN 61010-1, IEC 60664-1, overvoltage category III, pollution degree 2, double insulation on system with maximum 300 V rms to ground)

Environmental specifications

Operating temperature	From -25 to +55 °C/from -13 to +131 °F
Storage temperature	From -30 to +70 °C/from -22 to 158 °F

Note: R.H. < 90 % non-condensing @ 40 °C / 104 °F.

Compatibility and conformity

Directives	2014/35/EU (LVT - Low Voltage) 2014/30/EU (Electromagnetic Compatibility) 2011/65/EU (Electric-electronic equipment hazardous substances)
Standards	Electromagnetic compatibility (EMC) - emissions and immunity: EN 62052-11 Electrical safety: EN 61010-1 Metrology: EN62053-22, EN62053-23 Pulse output: IEC 62053-31, DIN 43864
Approvals	

Main unit



Description

Main unit with LCD display and touch keypad to view measurements, configure the system and manage two alarms.

It can be integrated by a digital output and communication module.

Four versions are available (AV4, AV5, AV6 and AV7) to manage different current and voltage inputs.

It can be quickly configured with OptoProg via optical port.

Main features

- System and phase variables (4 x 3 digits): V L-L, V L-N, A, W/var/VA, PF, Hz
- Active and reactive imported and exported energy meters (10 digits)
- Calculate the average and maximum system and phase power values
- Calculate current and voltage THD (total harmonic distortions) up to the 32nd harmonic
- Calculate load operating hours
- Rotating pages function
- Auxiliary power supply
- Two virtual alarms
- Backlit LCD display and touch keypad
- Optical port
- Detachable terminals
- Sealable terminal caps
- Configuration via keypad or UCS configuration software
- Filter to stabilize displayed measurements

Main functions

- Measure main electrical variables and harmonic voltage and current distortions
- Measure active and reactive energy
- Measure load operating hours
- Manage up to two alarms

Structure

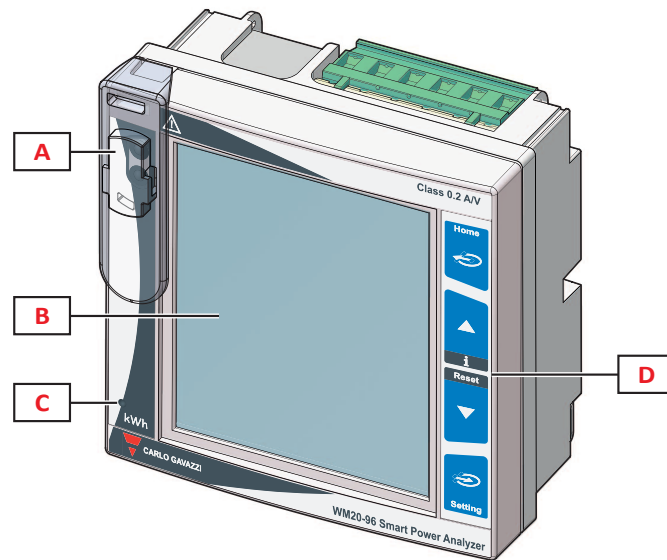

Fig. 1 Front

Element	Description
A	Optical port and plastic support for OptoProg (CARLO GAVAZZI) connection
B	Backlit LCD display
C	LED that blinks with frequency proportional to active energy consumption, see "LED" on page 13
D	Touch keypad

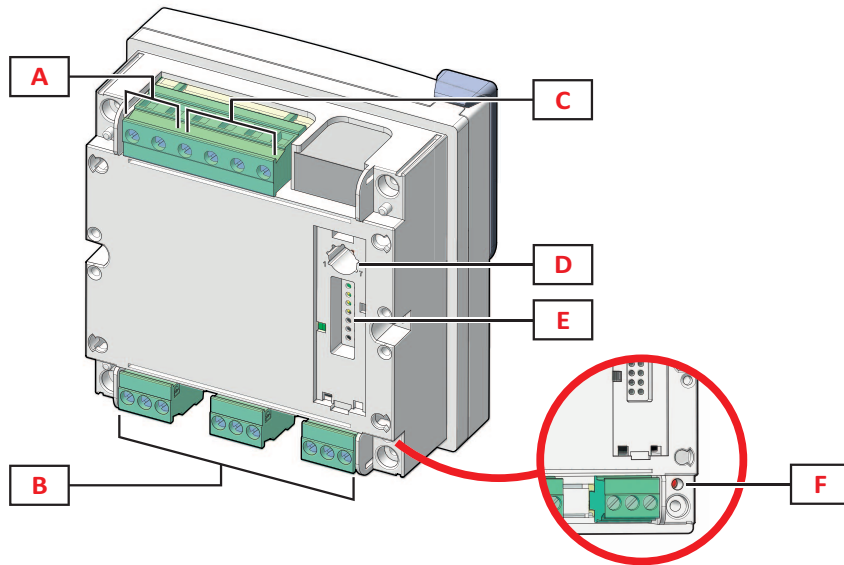

Fig. 2 Back

Element	Description
A	Detachable power supply terminals
B	Detachable current input terminals
C	Detachable voltage input terminals
D	Rotary selector to lock configuration
E	Local bus port for accessory modules
F	Power supply status LED, see "LED" on page 11 "LED" on page 13

Features

General

Assembly	Panel mounting
Weight	420g

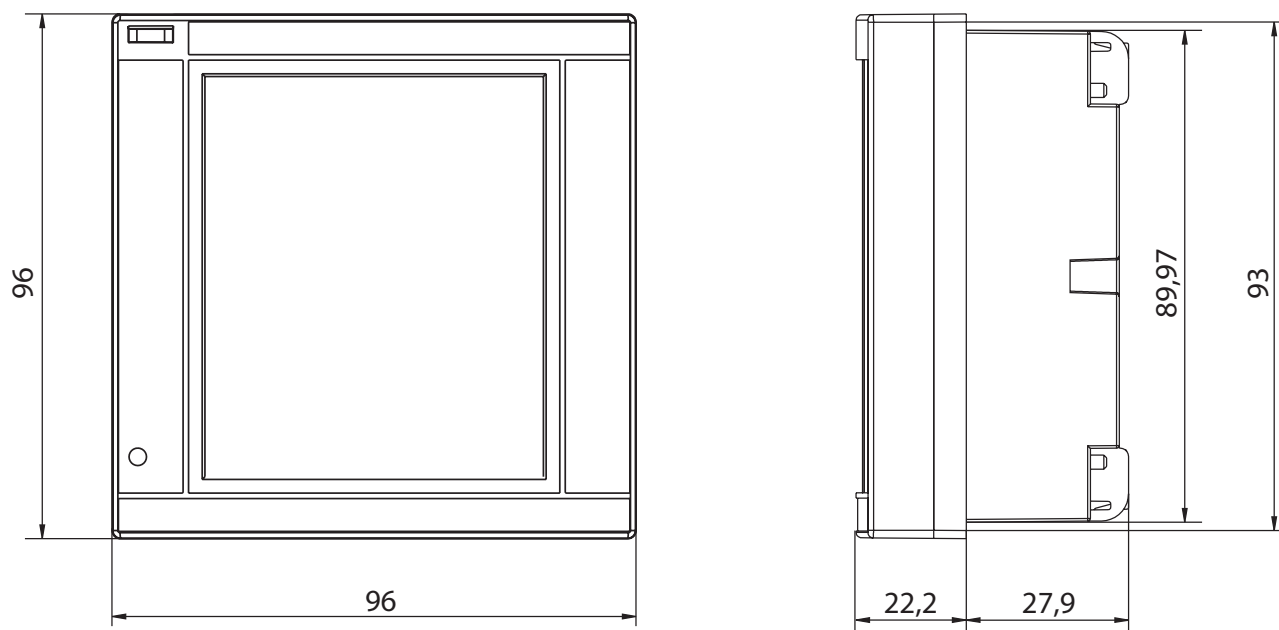

Electrical specifications

Electrical system	
Managed electrical system	Single-phase (2-wire) Two-phase (3-wire) Three-phase with neutral (4-wire) Three-phase without neutral (3-wire)

Voltage				
Inputs	AV4	AV5	AV6	AV7
Voltage connection	Direct or via VT/PT			
VT/PT transformation ratio	From 1 to 9999			
Rated voltage L-N (from Un min to Un max)	From 220 to 400 V		From 57.7 to 133 V	

Voltage		
Rated voltage L-L (from Un min to Un max)	From 380 to 690 V	From 100 to 230 V*
Voltage tolerance	-20%, + 15%	
Overload	Continuous: 1.2 Un max For 500 ms: 2 Un max	
Input impedance	>1.6 MΩ	
Frequency	From 40 to 440 Hz	

Note: *in case of two-phase or wild leg system: rated voltage L-L up to 240 V.

Note: in case of wild leg system (three-phase, four-wire delta) one of the line-to-neutral voltage can exceed the rated range in the table up to:

- 415 V (AV4, AV5)
- 208 V (AV6, AV7).

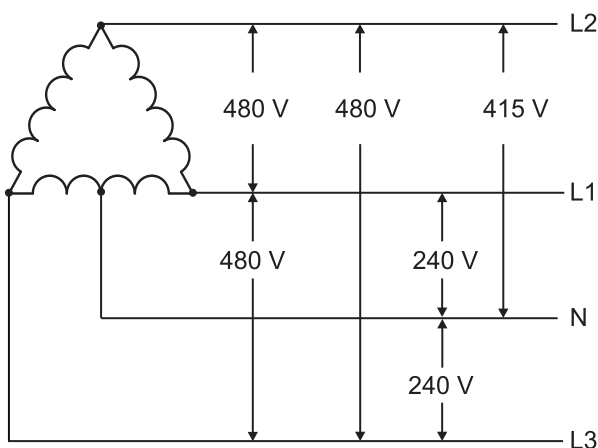

Fig. 3 AV4, AV5

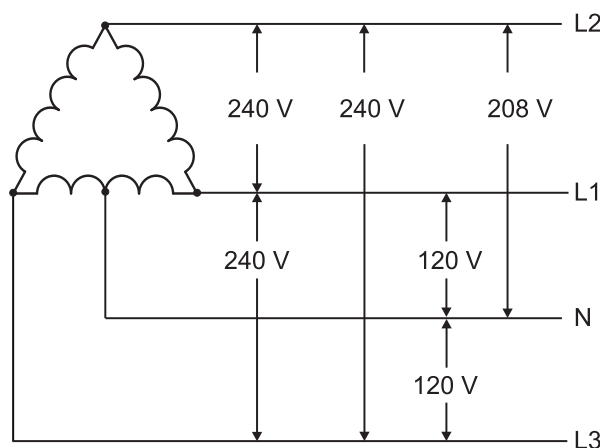

Fig. 4 AV6, AV7

Current				
Inputs	AV4	AV5	AV6	AV7
Current connection	Via CT			
CT transformation ratio	From 1 to 9999			
Rated current (In)	1 A	5 A		1 A
Minimum current (Imin)	0.01 A	0.05 A		0.01 A
Maximum current (Imax)	2 A	6 A		2 A
Start-up current (Ist)	1 mA	5 mA		1 mA
Overload	Continuous: Imax For 500 ms: 20 Imax			
Input impedance	< 0.2 VA			
Maximum CTxVT ratio	9999 x 9999			

Power supply

	H	L
Power supply	From 100 to 240 V ac/dc $\pm 10\%$	From 24 to 48 V ac/dc $\pm 15\%$
Consumption	3.5 W, 6 VA	

Measurements

Method	TRMS measurements of distorted waveforms
Sampling	3200 samples/s @50 Hz 3840 samples/s @60 Hz

Available measurements

Active energy	Unit	System	Phase
Imported (+) Total	kWh+	•	-
Imported (+) partial	kWh+	•	-
Exported (+) Total	kWh-	•	-
Exported (+) partial	kWh-	•	-

Reactive energy	Unit	System	Phase
Imported (+) Total	kvarh+	•	-
Imported (+) partial	kvarh+	•	-
Exported (+) Total	kvarh-	•	-
Exported (+) partial	kvarh-	•	-

Electrical variable	Unit	System	Phase
Voltage L-N	V	•	•
Voltage L-L	V	•	•
Current	A	•	•
Active power	kW	•	•
DMD	kW	•	•
MAX	kW	•	•
DMD MAX	kW	•	•
Apparent power	kVA	•	•
DMD	kVA	•	•
MAX	kVA	•	•
DMD MAX	kVA	•	•
Reactive power	kvar	•	•
DMD	kvar	•	•

Electrical variable	Unit	System	Phase
MAX	kvar	•	•
DMD MAX	kvar	•	•
Power factor	PF	•	•
Frequency	Hz	•	-
THD Current*	THD A %	-	•
THD Voltage L-N*	THD L-N %	-	•
THD Voltage L-L*	THD L-L %	-	•
Run hour meter	h	•	-

Note: the available variables depend on the type of system set.

* Up to 15th harmonic

Measurement accuracy

Current	
From 0.05 In to I _{max}	$\pm(0.2\% \text{ rdg} + 2\text{dgt})$
From 0.01 In to 0.05 In	$\pm(0.5\% \text{ rdg} + 2\text{dgt})$

Phase-phase voltage	
From U _n min -20% to U _n max +15%	$\pm(0.5\% \text{ rdg} + 1\text{dgt})$

Phase-neutral voltage	
From U _n min -20% to U _n max +15%	$\pm(0.2\% \text{ rdg} + 1\text{dgt})$

Active and apparent power	
From 0.05 In to I _{max} (PF=0.5L, 1, 0.8C)	$\pm(0.5\% \text{ rdg} + 1\text{dgt})$
From 0.01 In to 0.05 In (PF=1)	$\pm(1\% \text{ rdg} + 1\text{dgt})$

Reactive power	
From 0.1 In to I _{max} (sinφ=0.5L, 0.5C) From 0.05 In to I _{max} (sinφ=1)	±(1% rdg + 1 dgt)
From 0.05 In to 0.1 In (sinφ=0.5L, 0.5C) From 0.02 In to 0.05 In (PF=1)	±(1.5% rdg + 1 dgt)
Power factor	±[0.001+0.5%(1 – PF rdg)]
Active energy	Class 0.5S (EN62053-22), class 0.5 (ANSI C12.20)
Reactive energy	Class 2 (EN62053-23, ANSI C12.1)
THD	±1%

Frequency	
From 45 to 65 Hz	±(0.02% rdg + 1 dgt)
From 65 to 340 Hz	±(0.05% rdg + 1 dgt)
From 340 to 440 Hz	±(0.1% rdg + 1 dgt)

Display

Type	Backlit LCD
Refresh time	500 ms
Description	4 rows: 1st: 10 digits (7.5 mm) 2nd, 3rd, 4th: 4 digits (14 mm)
Variable readout	Instantaneous: 4 digits, min: 0.001 currents, 0.01 powers/PFs/frequency/THDs, 0.1 voltages, max: 9 999 Energy: 10 digits, min: 0.01, max: 9 999 999 999

LED

Front	Red. Weight: proportional to energy consumption and depending on the CT and VT/PT ratio product (16 Hz maximum frequency):	
	Weight (kWh per pulse)	CT*VT/PT
	0.001	≤ 7
	0.01	From 7.1 to 70
	0.1	From 70.1 to 700
	1	From 700.1 to 7000
	10	From 7001 to 70 k
	100	> 70.01 k
Back	Green. Power supply status.	

Special functions

- Two virtual alarms (up or down alarm)
- Filter to stabilize variable measurements with high fluctuations
- Automatic measurement display sequence (rotating pages function)
- Load operating hour meter
- Total active and reactive energy meters and average and maximum values reset
- Optical port for configuration via OptoProg
- Password protected settings menu

Connection Diagrams

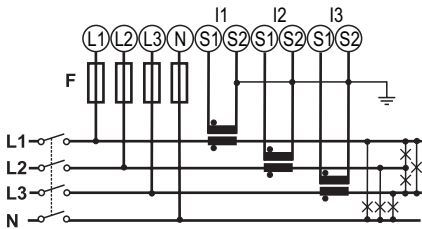

Fig. 5 Three-phase system with neutral (4-wire), unbalanced load and 3 CT. 315 mA fuse (F).

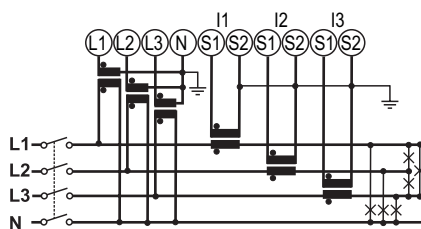

Fig. 6 Three-phase system with neutral (4-wire), unbalanced load, 3 CT and 3 VT/PT

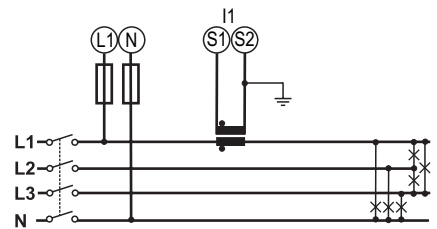

Fig. 7 Three-phase system with neutral (4-wire), balanced load, 1 CT. 315 mA fuse (F).

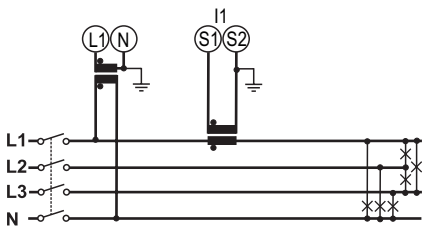

Fig. 8 Three-phase system with neutral (4-wire), balanced load, 1 CT and 1 VT/PT

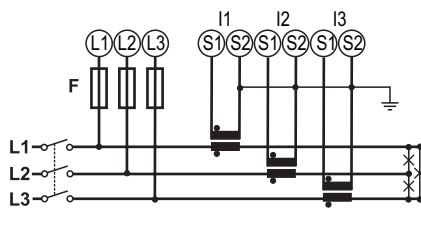

Fig. 9 Three-phase system without neutral (3-wire), unbalanced load and 3 CT. 315 mA fuse (F).

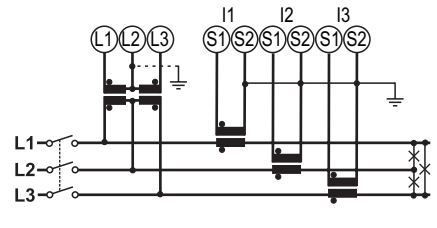

Fig. 10 Three-phase system with neutral (4-wire), balanced load, 1 CT and 1 VT/PT

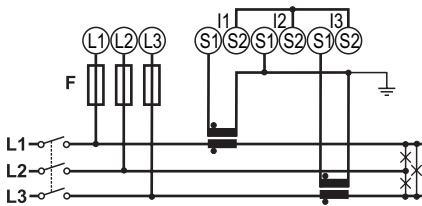

Fig. 11 Three-phase system without neutral (3-wire) unbalanced load and 2 CT (Aron). 315 mA fuse (F).

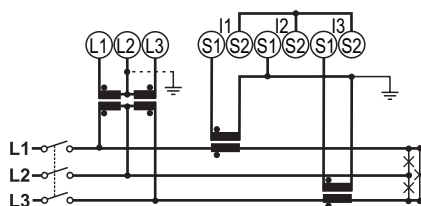

Fig. 12 Three-phase system without neutral (3-wire), unbalanced load, 2 CT (Aron) and 2 VT/PT.

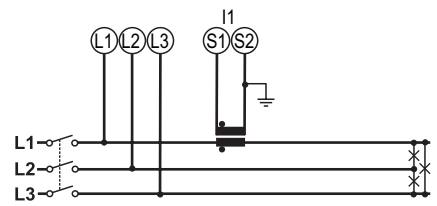

Fig. 13 Three-phase system without neutral (3-wire), balanced load, 1 CT.

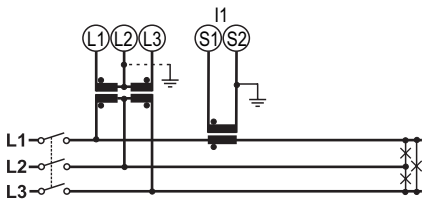

Fig. 14 Three-phase system without neutral (3-wire), balanced load, 1 CT and 2 VT/PT.

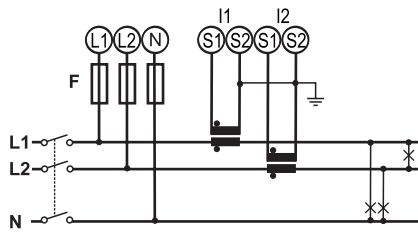

Fig. 15 Two-phase system (3-wire), 2 CT, 315 mA fuse (F).

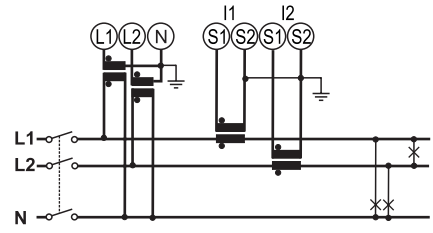

Fig. 16 Two-phase system (3-wire), 2 CT and 2 VT/PT.

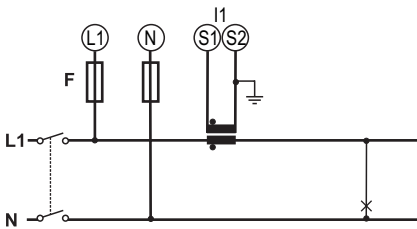

Fig. 17 Single-phase system (2-wire), 1 CT, 315 mA fuse (F).

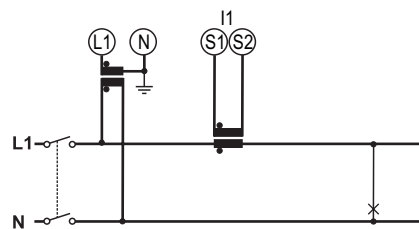

Fig. 18 Single-phase system (2-wire), 1 CT and 1 VT/PT.

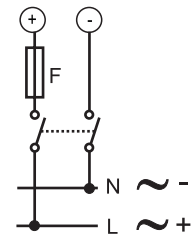

Fig. 19 Auxiliary power supply. 250 V [T] 630 mA fuse (F).

References

 WM20 AV 3 (9 characters total)

Enter the code option instead of

Code	Options	Description
W	-	-
M	-	-
2	-	-
0	-	-
A	-	-
V	-	-
<input type="checkbox"/>	4	From 380 to 690 V L-L ac, 1(2) A, connection via CT
	5	From 380 to 690 V L-L ac, 5(6) A, connection via CT
	6	From 100 to 230 V L-L ac, 5(6) A, connection via CT
	7	From 100 to 230 V L-L ac, 1(2) A, connection via CT
3	-	-
<input type="checkbox"/>	H	auxiliary power supply from 100 to 240 V ac/dc
	L	auxiliary power supply from 24 to 48 V ac/dc

Further reading

Information	Where to find it
Instruction manual - WM20	www.productselection.net

CARLO GAVAZZI compatible components

Purpose	Component name/code	Notes
Current measurement accessories	CTD1X, CTD2X, CTD3X, CTD4X	Solid core current transformers (1 or 5 A secondary current, 40 to 1600 A primary current) for cable or bus bar. See relevant datasheets.
	CTD1Z, CTD2Z, CTD3Z	Solid core current transformers (5 A secondary current, 40 to 600 A primary current) for cable or bus bar. See relevant datasheets.
	CTD5S, CTD6S, CTD8S, CTD9S, CTD10S	Split core current transformers (5 A secondary current, 100 to 3200 A primary current) for bus bar. See relevant datasheets.
	CTD8V, CTD8V, CTD9V, CTD9H, CTD10V, CTD10H	Solid core current transformers (1 or 5 A secondary current, 150 to 3200 A primary current) for bus bar. See relevant datasheets.
	CTD8Q	Solid core current transformers (1 or 5 A secondary current, 1000 to 4000 A primary current) for bus bar. See relevant datasheets.
Manage two digital outputs/associate alarms to digital outputs	M O O2 M O R2	See "Digital output modules"
Transmit data remotely	M C 485232 M C ETH M C BAC IP M C BAC MS M C PB	See "Communication modules"
Configure analyzer via desktop application	UCS configuration software	Available for free download at: www.gavazziautomation.com
Monitor data from several analyzers	UWP 3.0	See relevant datasheet
Quickly configure several analyzers via optical interface	OptoProg	See relevant datasheet
RS485/USB conversion	SIU-PC3	See relevant datasheet

Digital output modules



Description

Accessory module for WM analyzer family that associates static or relay outputs to alarms and/or transmits pulses proportional to energy consumption. Each output can run three different functions: alarm, remote control or pulse.

Main features

- Two digital outputs (static or relay)
- Three possible functions for each output
- Configuration via main unit keypad or UCS configuration software
- Easy mounting on main unit
- Detachable terminals
- Local bus connection to main unit

Main functions

- Manage two static or relay outputs
- Associate static or relay outputs with alarms
- Transmit pulses proportional to energy consumption

Structure

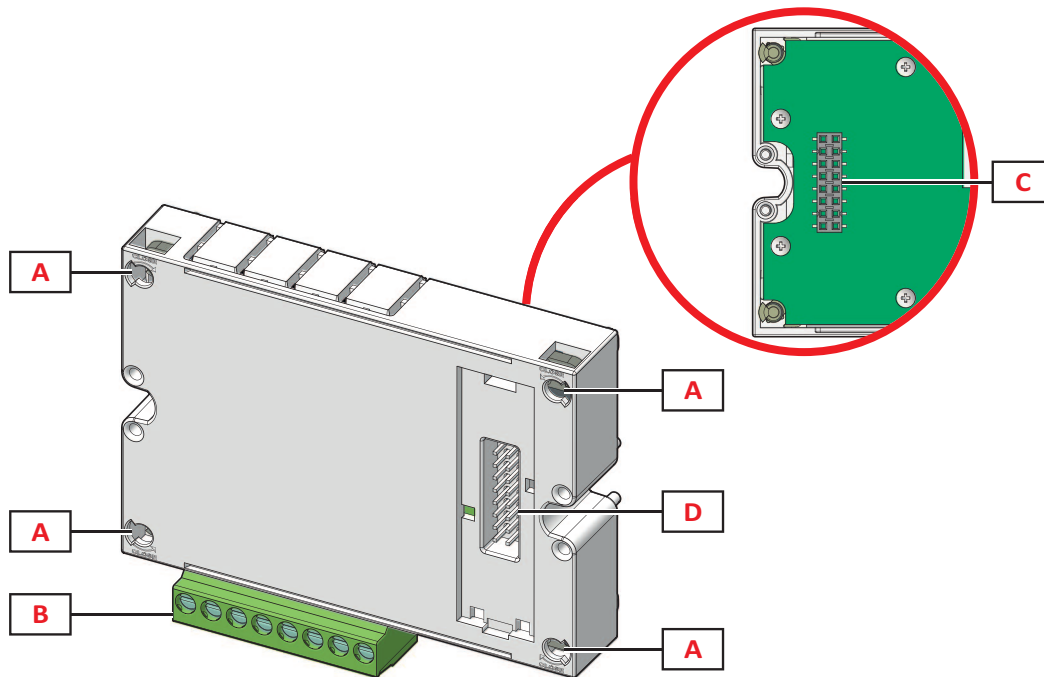

Fig. 20 Front

Element	Description
A	Main unit fastening pins
B	Detachable digital output terminals
C	Local bus port for main unit
D	Local bus port for communication module

▶ Digital output functions

Digital outputs can run three different functions:

- Alarm: output associated with an alarm and directly managed by WM20
- Remote control: output status managed via communication
- Pulse: pulse transmission output on active or reactive, imported or exported energy consumption.

Features

General

Mounting	On main unit
Weight	80g
Power supply	Self power supply via local bus

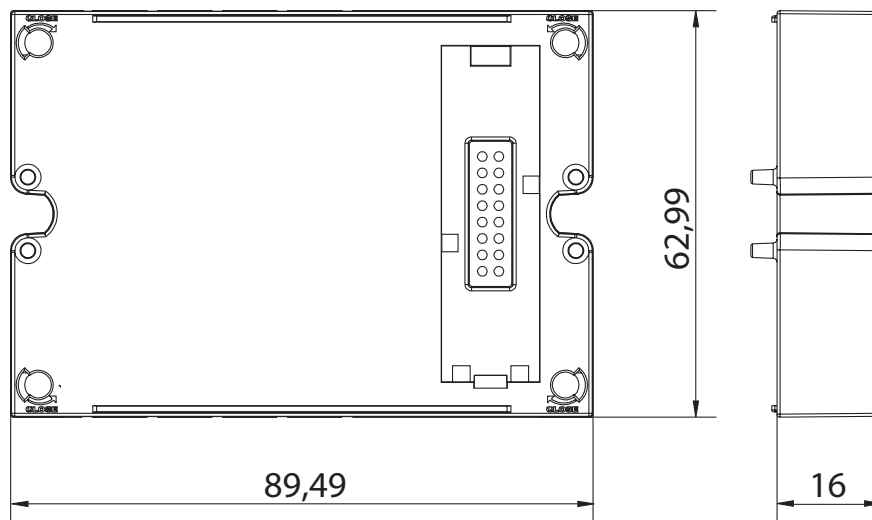

Static output module (M O O2)

Maximum number of outputs	2
Type	Opto-mosfet
Features	V_{ON} : 2.5 V dc, 100 mA max V_{OFF} : 42 V dc max
Configuration parameters	Output function: alarm/remote control/pulse Associated output alarm and normal status ("alarm" function only) Pulse weight, transmitted energy type, test transmission settings ("pulse" function only)
Configuration mode	Via keypad or UCS software

Relay output module (M O R2)

Maximum number of outputs	2
Type	SPDT relay

Features	AC1: 5 A @ 250 V ac AC15: 1 A @250 V ac
Configuration parameters	Output function: alarm/remote control/pulse Associated output alarm and normal status ("alarm" function only) Pulse weight, transmitted energy type, test transmission settings ("pulse" function only)
Configuration mode	Via keypad or UCS software

Connection Diagrams

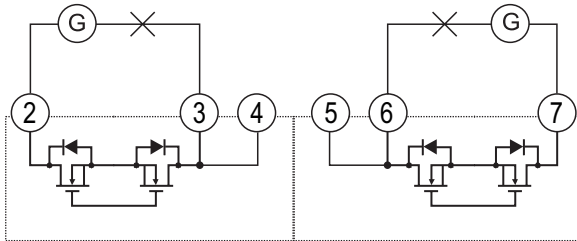

Fig. 21 M O O2. Double static opto-mosfet output.

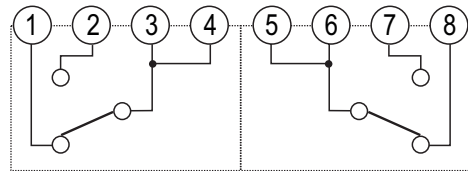

Fig. 22 M O R2. Double relay output.

References

▶ Order code

Code	Description
M O O2	Double static output
M O R2	Double relay output

▶ Further reading

Information	Where to find it
Instruction manual - WM20	www.productselection.net
Digital output module instruction manual	

▶ CARLO GAVAZZI compatible components

Purpose	Component name/-code	Notes
Power the module via analyzer	WM20 WM30 WM40	The digital output module only works connected to an analyzer. See relevant datasheets.

Communication modules



Description

Accessory module for WM analyzer family connected to the main unit that transmits system data remotely using a different communication protocol according to the version.

Main features

- Supported communication protocols: Modbus, BACnet, Profibus. See "Communication module overview " on page 21
- Configuration via main unit keypad or UCS configuration software
- Easy mounting on main unit
- Local bus connection to main unit

Main functions

- Transmit data remotely
- Configure the system

Communication module overview

Module code	Communication protocols	Port
M C 485232	Modbus RTU	RS485, RS232
M C ETH	Modbus TCP/IP	Ethernet
M C BAC IP	BACnet IP, Modbus TCP/IP	Ethernet
M C BAC MS	BACnet MS/TP	RS485
	Modbus TCP/IP	Ethernet
M C PB	Profibus DP V0 slaveRS485	RS485
	Modbus RTU	Micro-USB

Structure

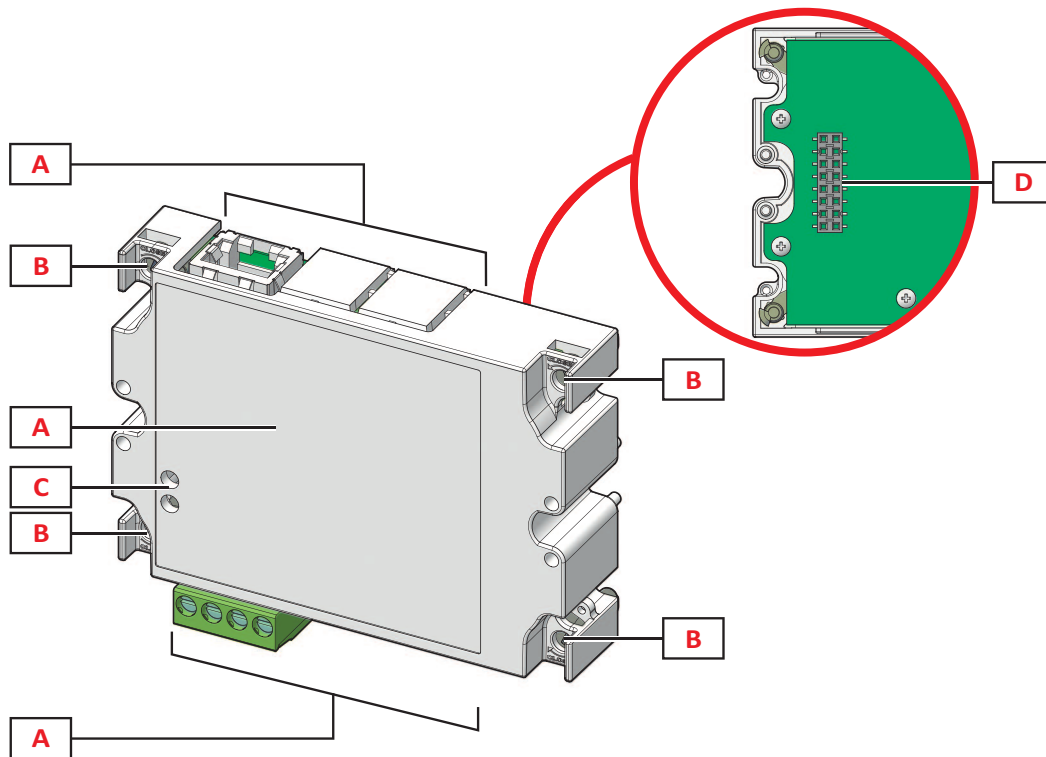

Fig. 23 Front

Note: NOTE: the image refers to the M C BAC MS module.

Element	Description
A	Communication port area Note: the communication ports depend on the communication module, see "Communication module overview" on page 21.
B	Main unit fastening pins
C	Communication status LED (M C 485232, M C BAC MS, M C PB)
D	Local bus port for main unit or digital output module

Features

General

Mounting	On main unit (with or without digital output module)
Weight	80g
Power supply	Self power supply via local bus

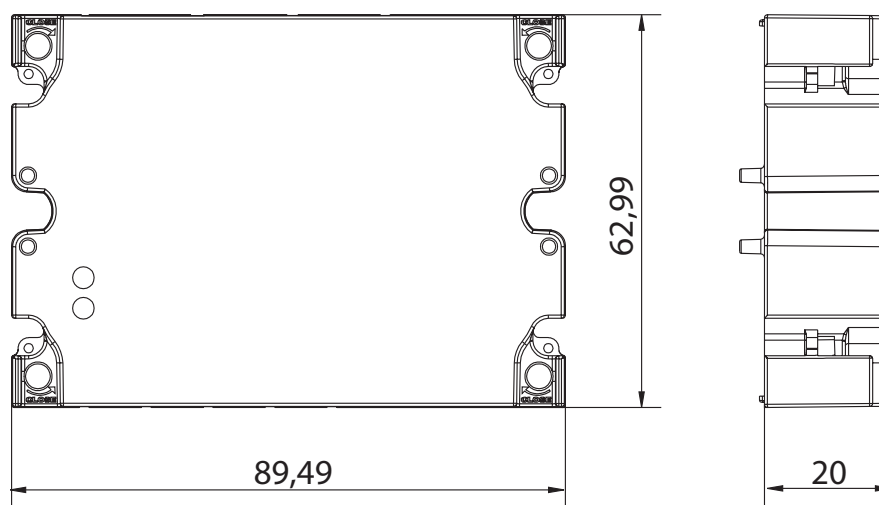

M C 485232 module

RS485 port	
Protocols	Modbus RTU
Devices on the same bus	Max 160 (1/5 unit load)
Communication type	Multidrop, bidirectional
Connection type	2 wires, maximum distance 1000 m
Configuration parameters	Modbus address (from 1 to 247) Baud rate (9,6/ 19,2/ 38,4/ 115,2 kbps) Parity (None/ Odd/ Even)
Configuration mode	Via keypad or UCS software

RS232 port	
Protocols	Modbus RTU
Communication type	Multidrop, bidirectional
Connection type	3 wires, maximum distance 15 m

RS232 port	
Configuration parameters	Modbus address (from 1 to 247) Baud rate (9,6/ 19,2/ 38,4/ 115,2 kbps) Parity (None/ Odd/ Even)
Configuration mode	Via keypad or UCS software

Note: the RS485 and RS232 ports are alternative.

LED	
Meaning	Communication status: Yellow: receiving Green: transmitting

M C ETH module

Ethernet port	
Protocols	Modbus TCP/IP
Client connections	Maximum 5 simultaneously
Connection type	RJ45 connector (10 Base-T, 100 Base-TX), maximum distance 100 m
Configuration parameters	IP address Subnet mask Gateway TCP/IP port
Configuration mode	Via keypad or UCS software

M C BAC IP module

Ethernet port

Protocols	BACnet IP (reading) Modbus TCP/IP (reading and configuration)
Client connections	(Modbus only) Maximum 5 simultaneously
Connection type	RJ45 connector (10 Base-T, 100 Base-TX), maximum distance 100 m
Configuration parameters	BACnet IP protocol: <ul style="list-style-type: none"> • Instance number (from 0 to 9999 via keypad, from 0 to 4194302 via communication) • Foreign Device enabling • BBMD address • UDP port • WM20 time-to-live recording as Foreign Device on specified BBMD server Modbus TCP/IP protocol: <ul style="list-style-type: none"> • IP address • Subnet mask • Gateway • TCP/IP port
Configuration mode	Via keypad or UCS software

M C BAC MS module

RS485 port	
Protocols	BACnet MS/TP (measurement reading and object description writing)
Communication type	Multidrop, monodirectional
Connection type	2 wires, maximum distance 1000 m
Supported services	"I-have", "I-am", "Who-has", "Who-is", "Read-property (multiple)"
Supported objects	Type 2 (analogue value including COV property), type 5 (binary value, for alarm transmission), type 8 (device)
Configuration parameters	BACnet IP protocol: <ul style="list-style-type: none"> Instance number (from 0 to 9999 via keypad, from 0 to 4194302 via communication) Baud rate (9,6/ 19,2/ 38,4/ 57,6/ 76,8 kbps) MAC address (from 0 to 127)
Configuration mode	Via keypad or UCS software

Ethernet port	
Protocols	Modbus TCP/IP (configuration)
Client connections	(Modbus only) Maximum 5 simultaneously
Connection type	RJ45 connector (10 Base-T, 100 Base-TX), maximum distance 100 m
Configuration parameters	IP address Subnet mask Gateway TCP/IP port
Configuration mode	Via keypad or UCS software

LED	
Meaning	Communication status: Yellow: receiving Green: transmitting

M C PB module

Profibus port	
Protocols	Profibus DP V0 slave
Connection type	9-pin D-sub receptacle RS485
Configuration parameters	Address, via keypad Other settings with UCS software via serial communication
Configuration mode	Via keypad or UCS software

Micro-USB port	
Protocols	Modbus RTU
Type	USB 2.0 (USB 3.0 compatible)
Connection type	Micro-USB B
Baud rate	Any (maximum 115.2 kbps)
Address	1

LED	
Meaning	Communication status: Red: between module and main unit Green: between module and Profibus master

Connection Diagrams

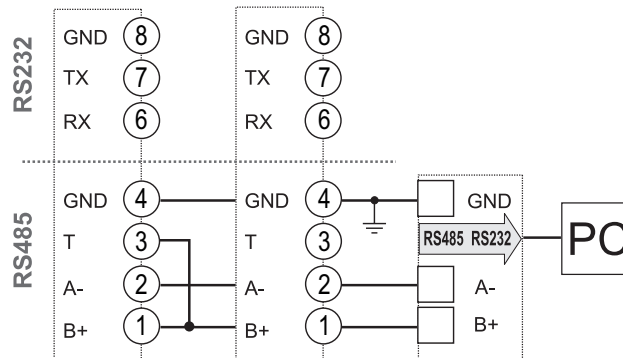

Fig. 24 M C 485232. RS485 serial port.

Note: additional meters with RS485 are connected in daisy chain. The serial output must only be terminated on the last network meter connecting terminals B+ and T.

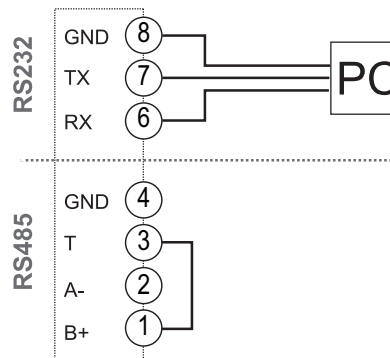

Fig. 25 M C 485232. RS232 serial port.

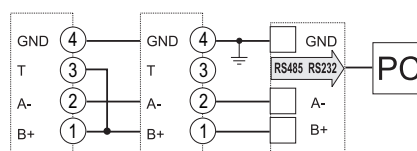

Fig. 26 M C 485232. RS232 serial port.

Note: additional meters with RS485 are connected in daisy chain. The serial output must only be terminated on the last network meter connecting terminals B+ and T.

References

Order code

Code	Description
MC 485232	Modbus RTU communication on RS485/RS232
MC ETH	Modbus TCP/IP communication on Ethernet
MC BAC IP	BACnet IP communication on Ethernet
MC BAC MS	BACnet MS/TP communication on RS485
MC PB	Profibus DP V0 communication on RS485

Further reading

Information	Where to find it
WM20 instruction manual	www.productselection.net
Communication module instruction manual (M C 485232, M C ETH, M C BAC IP, M C BAC MS)	
Communication module instruction manual (M C PB)	

CARLO GAVAZZI compatible components

Purpose	Component name/-code	Notes
Power the module via analyzer	WM20 WM30 WM40	The communication module only works connected to an analyzer. See relevant datasheets.



COPYRIGHT ©2022

Content subject to change. Download the PDF: www.gavazziautomation.com