

EM24 W1



Energy analyzer for three-phase systems



Description

Three-phase energy analyzer for DIN-rail mounting with configuration joystick, frontal selector and LCD display. Direct connection up to 65A or via current and voltage transformers. . The wireless M-Bus version is the perfect solution when cabling is not possible.

Applications

EM24 W1 is the perfect solution in any application, specially in building and industrial automation where energy and main electrical variables monitoring is required.

EM24 W1 is particularly suited for:

- energy efficiency monitoring
- cost allocation
- fiscal/legal sub-billing, where the wireless M-Bus version is the best choice for quick and easy installation without cables. Encryption ensures data security and safeguards confidentiality.

Main functions

- Measurement of energy consumption and main electrical variables of single-phase, two-phase or three-phase loads.
- Display of single phase measurements and total measurements.
- Easy connection function.
- Transmission of data via wireless M-Bus (868 MHz for the European market).
- Two wireless M-Bus versions: a compact model with internal antenna and a SMA connector model with external antenna (in case of metallic switchboard).

Benefits

- **Time saving set-up**, by frontal joystick and selector.
- **Error-proof installation**, by self-power supply and phase sequence detection.
- **Easy variable scrolling**, by means of the front joystick.
- **Flexible installation**, by means of the direct connection up to 65 A or the connection of 5 A current transformers.
- **Accurate measurement**, it is compliant with the international accuracy standard EN IEC 62053-21, and the EN IEC 61557-12 performance requirements (active power and active energy).
- **Legal metrology**, guaranteed by the MID approval.
- **Wireless communication**, wireless M-Bus version allows remote data collection when cabling is not possible due to cost or installation requirements.
- **Easy commissioning** of wireless communication thanks to the test function of the joystick and to transmission counter for diagnostics.

Main features

- TRMS measurements of distorted sine waves (voltages/currents)
- Data encryption (a unique key will be provided for any device in a sealed envelope included in the instrument box)
- Compliant with EN IEC 61557-12 performance requirements (active power and active energy)

Structure

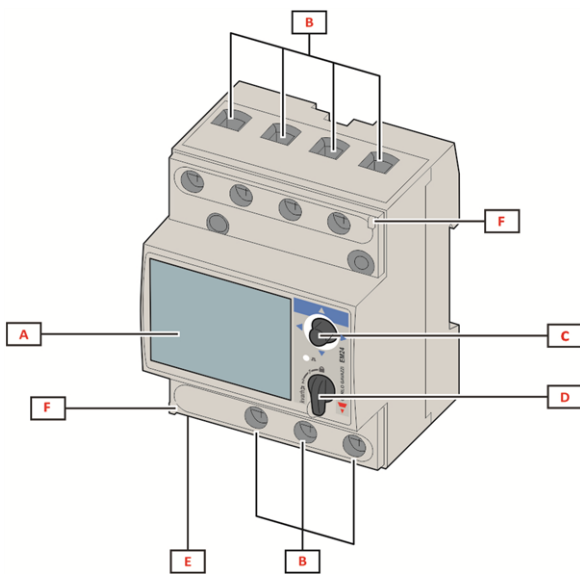

Fig. 1 Direct connection

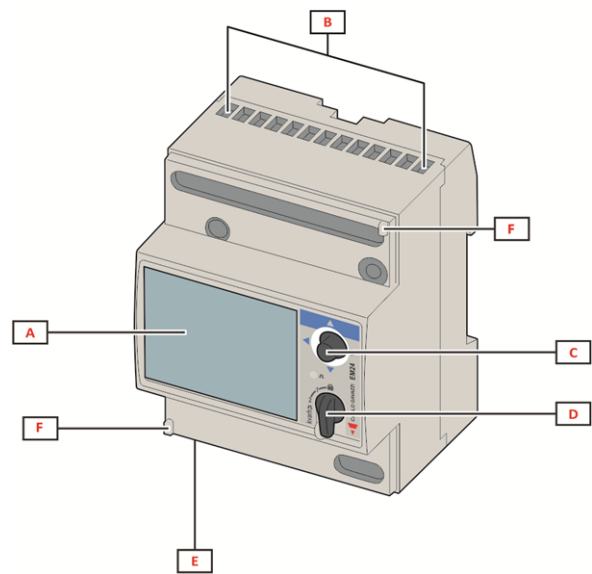

Fig. 2 CT connection

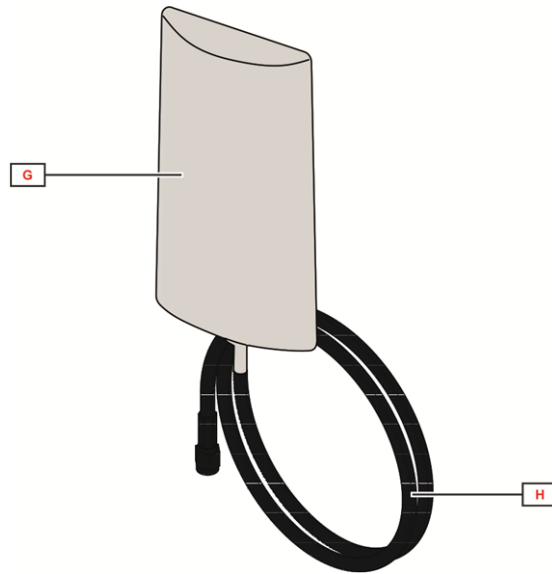

Fig. 3 External antenna (only for EM24DINAV...W1E...)

Area	Description
A	LCD display
B	Voltage/current connections
C	Joystick
D	Selector with pin for MID seal (programming block)
E	Inputs/outputs or communication port
F	Pins for MID seal (protection covers included)
G	External antenna for wireless M-Bus communication
H	SMA connector cable (2 m)

Features

General

Protection degree	Front: IP50. Terminals: IP20
Terminals	AV2 models: Measurement inputs: 2.5 to 16 mm ² / 1.7 to 3 Nm; Other inputs: 1.5 mm ² / 0.4 to 0.8 Nm AV5 models: Measurement inputs and other inputs: 1.5 mm ² max. / 0.4 to 0.8 Nm
Overvoltage category	Cat. III
Utilisation category	UC2
Pollution degree	2
Noise rejection (CMRR)	100 dB, from 42 to 62 Hz
Mounting	DIN rail
Weight	400 g (packaging included) 800 g with external antenna (packaging included)

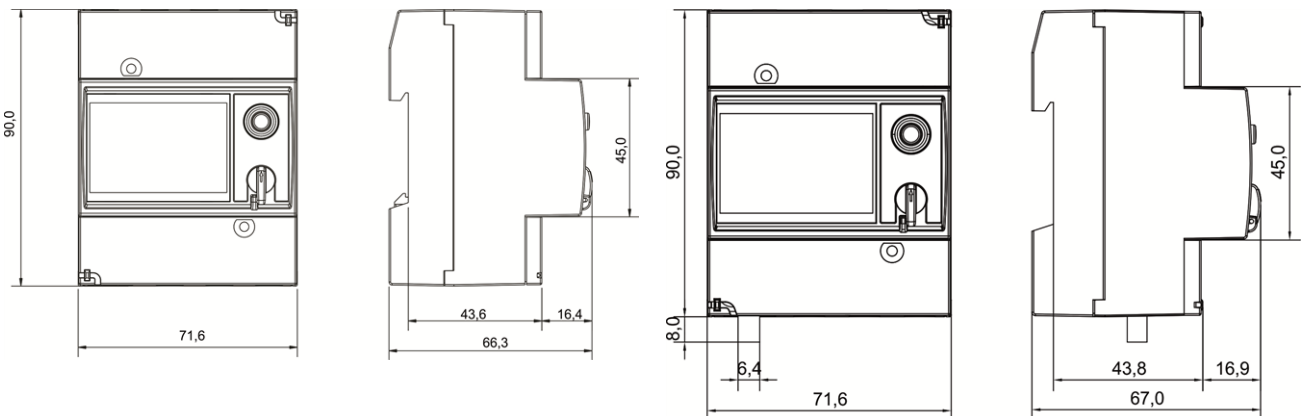

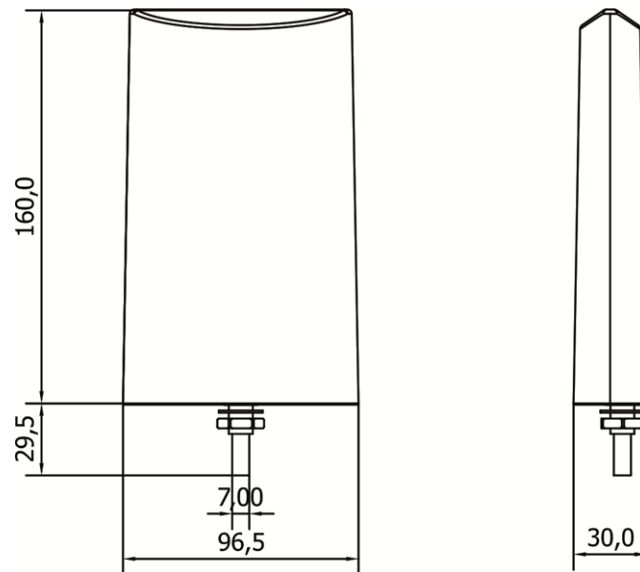

Environmental specifications



Operating temperature	From -25 to +55 °C / from -13 to +131 °F
Storage temperature	From -30 to +70 °C / from -22 to +158 °F

NOTE: R.H. < 90 % non-condensing @ 40 °C / 104 °F.

Input and output insulation

Type	Measuring inputs	Open collector outputs	Communication port	Self power supply
Measuring inputs	-	4 kV	4 kV	0 kV
Open collector outputs	4 kV	-	-	4 kV
Communication port	4 kV	-	-	4 kV
Self power supply	0 kV	4 kV	4 kV	-

Compatibility and conformity

Directives	2011/65/EU (RoHs) 2014/53/EU (RED)
Standards	Electromagnetic compatibility (EMC) - emissions and immunity: EN IEC 62052-11 Electrical safety: EN IEC 61010-1, EN 50470-1 (MID) Accuracy: EN IEC 62053-21, EN IEC 62053-23, EN 50470-3 (MID), EN IEC 61557-12 (active power and active energy, MID models only)
Approvals	  MID (PF only)

Electrical specifications

Voltage - MID models		
Voltage inputs	AV2	AV5
Voltage connection	Direct	
Rated voltage L-N (from U_n min. to U_n max.)	133 to 230 V	230 V
Rated voltage L-L (from U_n min. to U_n max.)	230 to 400 V	400 V
Voltage tolerance	-20%, +15%	
Input impedance	Refer to "Power supply"	
Frequency	50 Hz	

Voltage - Non MID models (according to EN IEC 62052-11)		
Voltage inputs	AV2	AV5
Voltage connection	Direct	
Rated voltage L-N (from U_n min. to U_n max.)	120 to 277 V	120 to 277 V
Rated voltage L-L (from U_n min. to U_n max.)	208 to 480 V	208 to 480 V
Voltage tolerance	-20%, +15%	
Input impedance	Refer to "Power supply"	>1600 k Ω
Frequency	50/60 Hz	

Current		
Current inputs	AV2	AV5
Current connection	Direct	Via CT
Rated current (I_n)	-	5 A
Base current (I_b)	10 A	-
Minimum current (I_{min})	0.5 A	0.05 A
Maximum current (I_{max})	65 A	10 A
Start-up current (I_{st})	0.04 A	0.01 A
Overload	Continuous: 65 A @50 Hz For 10 ms: 1950 A @50 Hz	Continuous: 10 A @50 Hz For 500 ms: 200 A @ 50 Hz
Short circuit withstand	For 10 ms: 4500 A according to EN IEC 62052-31:2015	-
Input impedance	< 1.1 VA	< 0.6 VA
Crest factor	4 (92 A max. peak)	3 (15 A max. peak)

Maximum CTxVT ratio		
Current inputs	AV2	AV5
Non-MID models	-	6975
MID models	-	2615

Power supply

Non MID models		
	AV2	AV5
Type	Self power supply	
Consumption	2.7 VA / 1.8 W	

MID models		
	AV2	AV5
Type	Self power supply	
Consumption	2.7 VA / 1.8 W	

Measurements

Method	TRMS measurements of distorted waveforms
Sampling	1600 samples/s @50 Hz 1900 samples/s @60 Hz

 Available measurements

Active energy	Unit	System	Phase	Note
Imported (+) Total	kWh+	•	•	
Imported (+) partial	kWh+	•	-	
Exported (-) Total	kWh-	•	-	

Reactive energy	Unit	System	Phase
Imported (+) Total	kvarh+	•	-
Imported (+) partial	kvarh+	•	-
Exported (-) Total	kvarh-	•	-
Imported (+) by tariff	kvarh+	•	-

Electrical variable	Unit	System	Phase
Voltage L-N	V	•	•
Voltage L-L	V	•	•
Current	A	-	•
DMD MAX	A	•	-
Active power	kW	•	•
DMD	kW	•	-
#DMD MAX	kW	•	-
Apparent power	kVA	•	•
DMD	kVA	•	-
DMD MAX	kVA	•	-
Reactive power	kvar	•	•
Power factor	PF	•	•
Frequency	Hz	•	-
Run hour meter	h	•	-

Measurement mode

Depending on the APPLICATION setting, a different selection of variables is available on the display (see manual) and the energy calculation is worked out as follows:

- Standard: both kWh+ and kWh- are available;
- EC: easy connection function, the power is always integrated (both in case of positive and negative power).

In MID analyzers the calculation depends on the model:

- PFA: Easy connection, the total energy totalizer (kWh+) is certified according to MID;
- PFB: only the total positive totalizer (kWh+) is certified according to MID. The negative energy totalizer is available but not certified according to MID.

Energy metering

For every measuring interval time, the energies of the single phases are summed; according to the sign of the result, the positive (kWh+) or negative totalizer (kWh-) is increased.

Example:

P L1= +2 kW, P L2= +2 kW, P L3= -3 kW

Integration time = 1 hour

+kWh=(+2+2-3)x1h=(+1)x1h=1 kWh

-kWh=0 kWh

Measurement accuracy

Current	AV2	AV5
From 0.5 A to 2 A	$2 \pm(0.5\% \text{ rdg} + 3\text{dgt})$	-
From 2 A to 65 A	$\pm(0.5\% \text{ rdg} + 1\text{dgt})$	-
From 0.05 A to 1 A	-	$\pm(0.5\% \text{ rdg} + 3\text{dgt})$
From 1 A to 10 A	-	$\pm(0.5\% \text{ rdg} + 1\text{dgt})$

Phase-phase voltage	AV2	AV5
In the range U_n	$\pm(1\% \text{ rdg} + 1\text{dgt})$	

Phase-neutral voltage	AV2	AV5
In the range U_n	$\pm(0.5\% \text{ rdg} + 1\text{dgt})$	

Active and apparent power	AV2	AV5
From 1.0 A to 65.0 A (PF=0.5 L, 1, 0.8 C)	$\pm(1\% \text{ rdg} + 1\text{dgt})$	-
From 0.5 A to 1.0 A (PF=1)	$\pm(1.5\% \text{ rdg} + 1\text{dgt})$	-
From 0.25 A to 10 A (PF=0.5 L, 1, 0.8 C)	-	$\pm(1\% \text{ rdg} + 1\text{dgt})$
From 0.05 A to 0.25 A (PF=1)	-	$\pm(1.5\% \text{ rdg} + 1\text{dgt})$

Reactive power	AV2	AV5
From 1.0 A to 2.0 A ($\sin\phi=0.5$ L, 0.5 C) From 0.5 A to 1.0 A ($\sin\phi=1$)	$\pm(2.5\% \text{ rdg} + 1 \text{dgt})$	-
From 2.0 A to 65.0 A ($\sin\phi=0.5$ L, 0.5 C) From 1.0 A to 65.0 A ($\sin\phi=1$)	$\pm(2\% \text{ rdg} + 1 \text{dgt})$	-
From 0.25 A to 0.5 A ($\sin\phi=0.5$ L, 0.5 C) From 0.1 A to 0.25 A ($\sin\phi=1$)	-	$\pm(2.5\% \text{ rdg} + 1 \text{dgt})$
From 0.5 A to 10 A ($\sin\phi=0.5$ L, 0.5 C) From 0.25 A to 10 A ($\sin\phi=1$)	-	$\pm(2\% \text{ rdg} + 1 \text{dgt})$
Active energy	Class 1 (EN IEC 62053-21) Class B (EN 50470-3) (MID)	
Reactive energy	Class 2 (EN IEC 62053-23)	

Frequency	
From 45 to 65 Hz	$\pm 0.1 \text{ Hz}$

Measurement accuracy according to EN IEC 61557-12 (MID models)	
Active power	Performance class 1
Active energy	Performance class 2

Display

Type	LCD
Refresh time	< 750 ms
Description	3 rows: 1 st : 8 digits (7 mm) 2 nd : 4 digits (7 mm) 3 rd : 4 digits (7 mm)
Variable readout	Instantaneous: 4 digits, min.: 0.000, max.: 9999 Energy: 8 digits (imported), 7 digits (exported), min.: 0.00, max.: 99 999 999

LED

Model	CT*VT	Weight (kWh per pulse)
AV5/AV6	≤ 7	0.001
	> 7 ≤ 70.0	0.01
	> 70 ≤ 700.0	0.1
	> 700	1
AV2/AV9	N/A	0.001

Wireless M-Bus (W1)

Protocols	Wireless M-Bus according to EN13757-3, EN13757-4
Frame format	A
Frequency	868 MHz
Frame type	Selectable among the following options: -1: kWh+ -2: kWh+, kvarh+, kvarh-, kW+ -3: kWh+, kvarh+, kvarh-, kW+, kvar+, kvar-, current by phase, voltage by phase, frequency -4: kWh+, kWh-, kvarh+, kvarh-, kW+, kW-, kvar+, kvar-
Mode	T1 or C1
Encryption	No encryption, ENC-Mode 5 or ENC-Mode 7
Transmission interval	Selectable from 10 s to 60 min.
Configuration parameters	Frame Transmission mode Communication interval Encryption enabling
Configuration mode	Via joystick

Connection Diagrams

Three-phase with neutral (4-wire)

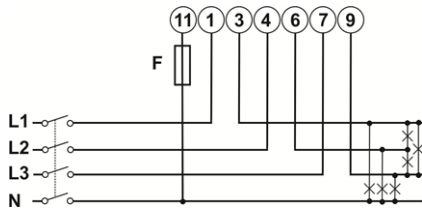

Fig. 4 AV2

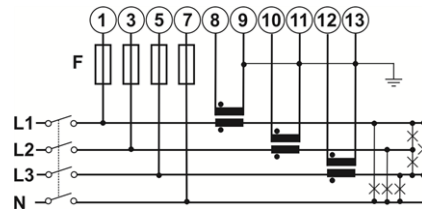

Fig. 5 AV5

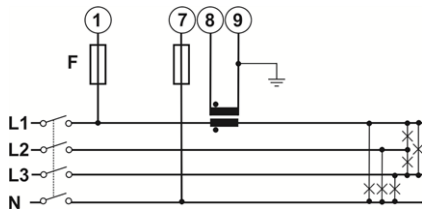

Fig. 6 AV5

Three-phase without neutral (3-wire)

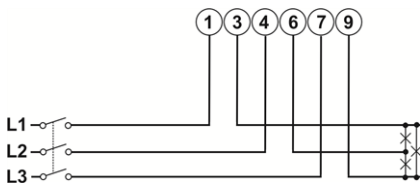

Fig. 7 AV2

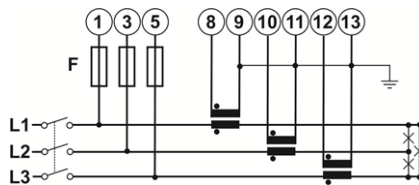

Fig. 8 AV5

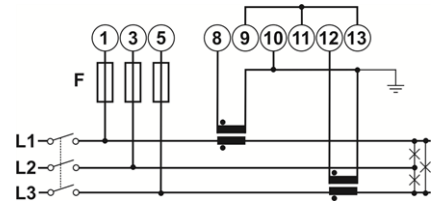

Fig. 9 AV5

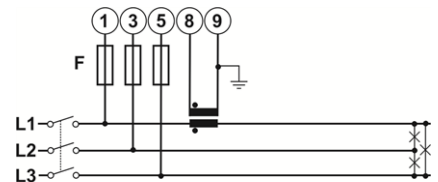

Fig. 10 AV5

Two-phase system with neutral (3-wire)

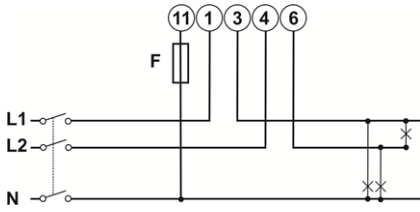

Fig. 11 AV2

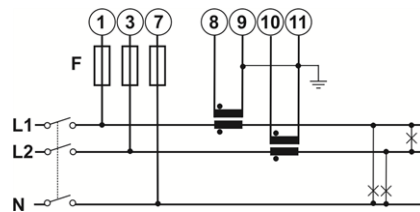

Fig. 12 AV5

Single-phase (2-wire)

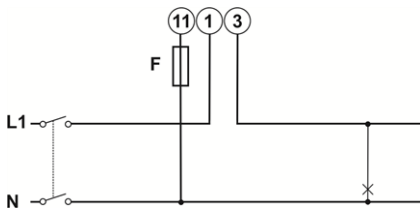

Fig. 13 AV2

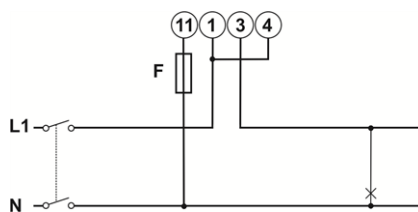

Fig. 14 AV2

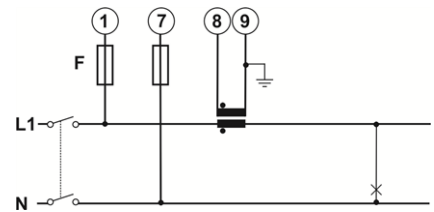

Fig. 15 AV5

NOTE: F=315 mA/250 mA time-delay

MID connection diagrams

Three-phase with neutral (4-wire)

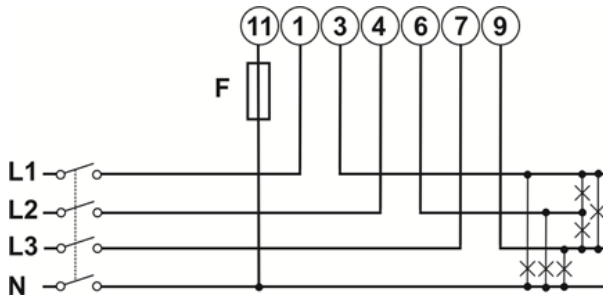

Fig. 16 AV2

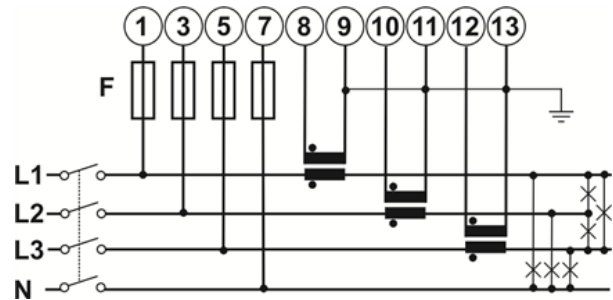

Fig. 17 Type

Three-phase without neutral (3-wire)

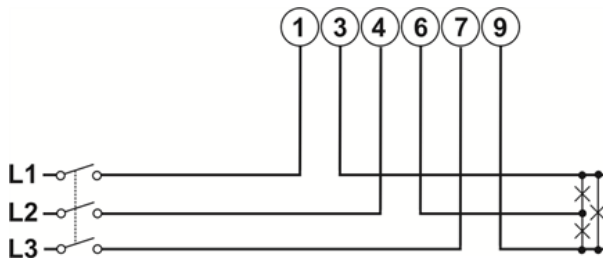

Fig. 18 AV2

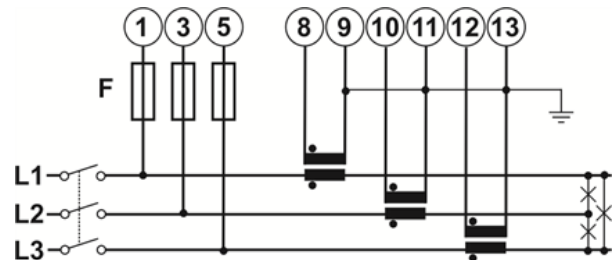

Fig. 19 Type

Single-phase (2-wire)

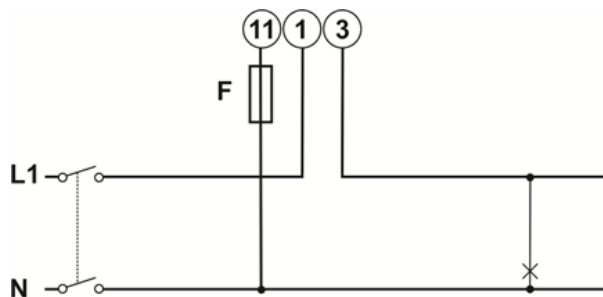

Fig. 20 AV2 1X

Note: $F=315\text{ mA}$

References

Order code

Non MID models

Component name/part number	I/O communication	Voltage inputs	Current inputs	Power supply
EM24DIN AV5 3X W1 I X	Wireless M-Bus, internal antenna	From 120 to 277 V L-N From 208 to 480 V L-L	5 (10) A via CT, 3-phase	Self power supply
EM24DIN AV5 3X W1 E X	Wireless M-Bus, external antenna	From 120 to 277 V L-N From 208 to 480 V L-L	5 (10) A via CT, 3-phase	Self power supply
EM24DIN AV2 3X W1 I X	Wireless M-Bus, internal antenna	From 120 to 277 V L-N From 208 to 480 V L-L	10 (65) A, 3-phase	Self power supply
EM24DIN AV2 3X W1 E X	Wireless M-Bus, external antenna	From 120 to 277 V L-N From 208 to 480 V L-L	10 (65) A, 3-phase	Self power supply
EM24DIN AV2 1X W1 I X	Wireless M-Bus, internal antenna, 1-phase	From 120 to 277 V L-N	10 (65) A, 1-phase	Self power supply
EM24DIN AV2 1X W1 E X	Wireless M-Bus, external antenna, 1-phase	From 120 to 277 V L-N	10 (65) A, 1-phase	Self power supply



MID models

Component name/part number	I/O communication	Voltage inputs	Current inputs	Power supply
EM24DIN AV5 3X W1 I PFA EM24DIN AV5 3X W1 I PFB	Wireless M-Bus, internal antenna	230 V L-N 400 V L-L	5 (10) A via CT	Self power supply
EM24DIN AV5 3X W1 E PFA EM24DIN AV5 3X W1 E PFB	Wireless M-Bus, external antenna	230 V L-N 400 V L-L	5 (10) A via CT	Self power supply
EM24DIN AV2 3X W1 I PFA EM24DIN AV2 3X W1 I PFB	Wireless M-Bus, internal antenna	230 V L-N 400 V L-L	10(65) A	Self power supply
EM24DIN AV2 3X W1 E PFA EM24DIN AV2 3X W1 E PFB	Wireless M-Bus, external antenna	230 V L-N 400 V L-L	10(65) A	Self power supply
EM24DIN AV2 1X W1 I PFA EM24DIN AV2 1X W1 I PFB	Wireless M-Bus, internal antenna, 1- phase	230 V L-N	10(65) A	Self power supply
EM24DIN AV2 1X W1 E PFA EM24DIN AV2 1X W1 E PFB	Wireless M-Bus, external antenna, 1- phase	230 V L-N	10(65) A	Self power supply

- PFA: Easy connection, the total energy totalizer (kWh+) is certified according to MID;
- PFB: only the total positive totalizer (kWh+) is certified according to MID. The negative energy totalizer is available but not certified according to MID.

Further reading

Information	Where to find it
User manual - W1	https://www.gavazziautomation.com/fileadmin/images/PIM/MANUALS/ENG/EM24_W1_IM_USE.pdf
Installation instruction - W1	https://www.gavazziautomation.com/fileadmin/images/PIM/MANUALS/ENG/EM24_W1_IM_INST.pdf

CARLO GAVAZZI compatible components

Purpose	Component name/part number	NOTES
Monitor data from several analyzers	VMU-C	See relevant datasheet
Collect data from wireless M-Bus devices and transmit data via Modbus TCP/IP	SIU-MBM-02	See relevant datasheet

